

313F L GC

Hydraulic Excavator



Engine

Engine Model	Cat® C3.4B	
Net Power – SAE J1349	52 kW	70 hp

Drive

Maximum Travel Speed	5.5 km/h	3.4 mph
Maximum Drawbar Pull	109.9 kN	24,706 lbf

Weight

Minimum Operating Weight	13 300 kg	29,300 lb
Maximum Operating Weight	14 600 kg	32,200 lb

Introduction

The new 313F L GC excavator is built for those who need dependable performance at a low cost per hour. The machine features an efficient C3.4B engine that's light on fuel – with no need for diesel exhaust fluid to meet today's emission standards. It also has a simple hydraulic system you can count on for everyday excavating tasks.

Unlike other brands in its size class, the 313F L GC comes equipped with more unique attributes: Robust booms and sticks, strong and stable undercarriage, a quiet and comfortable Roll-Over Protective Structure (ROPS) cab, and easy-to-reach service points are just a few.

Bottom line: If you are looking for a dependable, low-cost-per-hour excavator to get your work done – backed by unmatched support from a brand you can trust – look no further than the 313F L GC. It simply makes a great deal of business sense.

Contents

Engine	4
Hydraulics	5
Operator Station.....	6
Structures & Undercarriage	8
Front Linkage	9
Attachments.....	10
Simple Technologies	12
Serviceability.....	13
Transportability.....	14
Safety.....	15
Complete Customer Care.....	16
Sustainability.....	17
Specifications.....	18
Standard Equipment.....	33
Optional Equipment.....	34
Notes.....	35





Engine

Economical performance you can depend on



A Powerful, Economical Solution

The Cat C3.4B engine meets U.S. EPA Tier 4 Final emission standards and provides plenty of power for the work you do without consuming a lot of fuel to do it. The engine is equipped with unique yet simple features like a turbo protector and maintenance-free emissions package that enhance service life – all to help keep your owning and operating costs to an absolute minimum.

Fuel-Saving Features

There are built-in features to help you manage how much fuel you use. One-touch low idle lets you reduce engine speed when the machine isn't working. Engine idle shutdown turns the engine off when it's been idling for more than the time that you set. Both contribute to saving fuel, reducing emissions, and extending your service intervals.

Proven Technology

Every Tier 4 Final engine is equipped with a combination of proven electronic, fuel, air, and aftertreatment components. Applying these technologies lets us meet your high expectations for productivity, fuel efficiency, reliability, and service life. The right technologies fine tuned for the right applications results in the following:

- **High performance** across a variety of applications
- **Maximized uptime and reduced cost** with world-class support from the Cat dealer network
- **Minimized impact** of emission systems – designed to be transparent to the operator without requiring interaction
- **Durable designs** with long life to overhaul
- **Less fuel consumption** with minimized maintenance costs while providing the same great power and response

Hydraulics

Plenty of power for your line of work

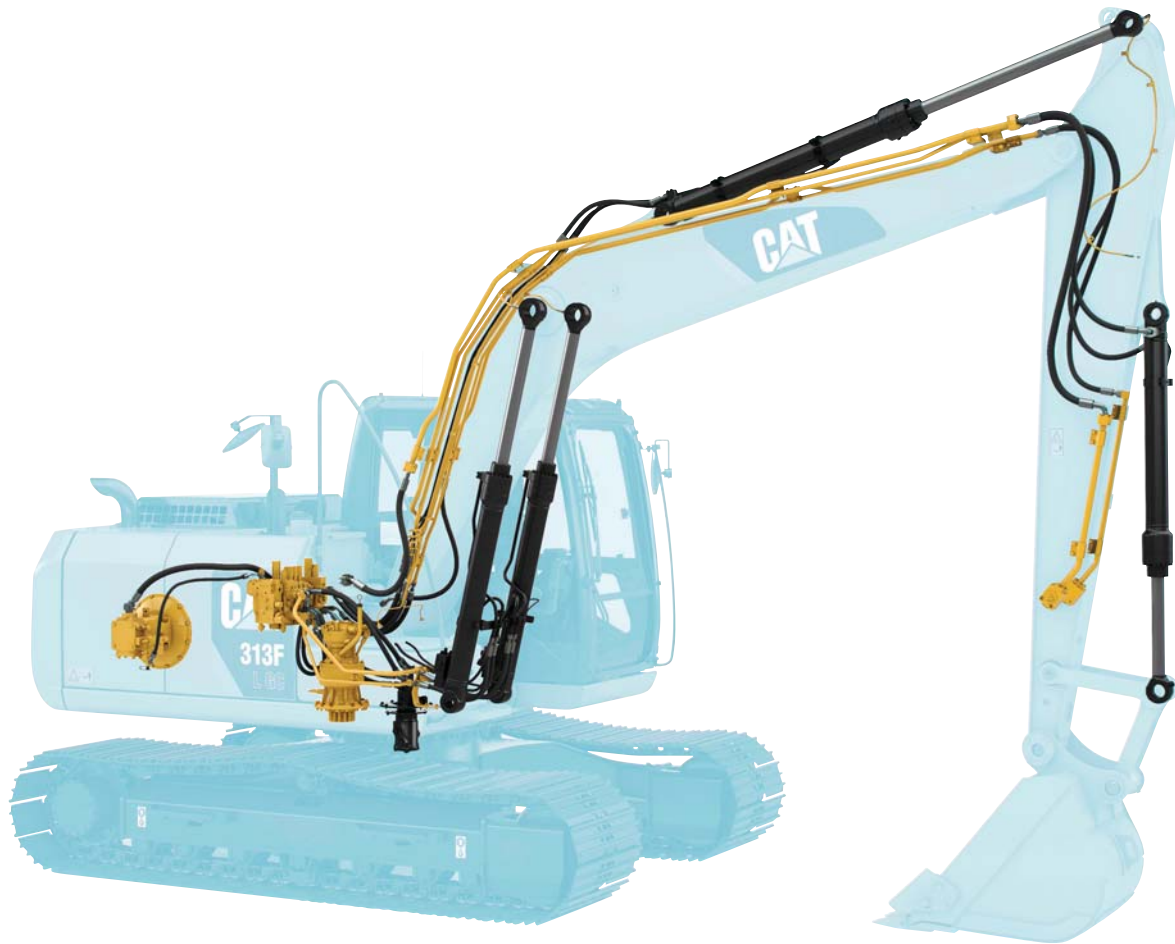

A Simple, Reliable System

The 313F L GC's hydraulic system is simple and reliable. The system uses a load-sense pump and a control valve that calculate required hydraulic flow so you can meet your daily job requirements quickly and efficiently.

A Logical Layout

Like all Cat excavators, hydraulic components on the 313F L GC are located close together in order to minimize the length of hydraulic lines. This logical layout leads to less pressure drops and more machine power for the work you need to do.

Maximum Versatility

When it comes to doing a variety of work, the machine's available high-pressure auxiliary and quick coupler circuits give you plenty of capability. An optional medium-pressure circuit (available from your local Cat dealer) adds more versatility. You can maximize that capability when you put Cat Work Tools out front. They will help you dig, load, break, and cut with confidence.

Less Components, Less Maintenance

The simple hydraulic system helps make the machine easier to maintain. The addition of a pilot manifold in the valve block means there is no need for a pilot pump, filter, or lines. Fewer components equal less maintenance and lower owning and operating costs for you.

Operator Station

Comfort and convenience to keep you productive



A Safe, Quiet Cab

The Roll-Over Protective Structure (ROPS) certified cab is not only a safety feature, but it is also a sound suppressor due to its special sealing and insulation. With the door and windows closed, you will experience a machine that's as quiet as the truck you drive to work.

A Great View

Ample glass gives you great views out front and to the side. A large rear window, aided by a low-profile engine, gives you excellent visibility out back. A large skylight provides great overhead visibility; it also serves as an emergency exit.

A Cool & Warm Environment

The automatic climate control system features multiple air outlets with filtered ventilation. Air flows on the floor, behind the seat, and in front of you to make your work in either hot or cold weather much more pleasant and productive.

Ample Storage & Auxiliary Power

Storage spaces are located in the front, rear, and side consoles of the cab. A drink holder accommodates a large mug, and a shelf behind the seat stores large lunch or toolboxes. Power supply sockets are available for charging your electronic devices like an MP3 player, a cell phone, or even a tablet.



A Comfortable Seat

The standard mechanical suspension seat includes a reclining back, upper and lower slide adjustments, and height and tilt angle adjustments to meet your needs for maximum comfort.



Controls Just For You

The right and left joystick consoles can be adjusted to improve your comfort and productivity during the course of a day. The right joystick features a button that will reduce engine speed when you are not working to help save fuel. Touch it once and speed reduces; touch it again and speed increases for normal operation.



An Easy-To-Use Monitor

The monitor displays critical information you need to operate efficiently. Not only can it memorize up to 10 different work tools, it's also programmable in up to 42 languages to meet today's diverse workforce.

Structures & Undercarriage

Designed for your tough applications



Robust Frames

The 313F L GC is a well-built machine that's designed to give you a long service life and excellent resale value. The upper frame includes special mountings made specially to support the heavy-duty cab; the lower frame is reinforced to enhance component durability so you can count on the machine doing the tough work you need to get done.

Durable Undercarriage

The machine's long undercarriage works extremely well in various work applications and conditions. Plus its track shoes, links, rollers, idlers, and final drives are all built with high-tensile-strength steel for long-term durability.

Great Weight

The rigid 2.45 mt (5,400 lb) counterweight matches the machine's overall sleek appearance, and it provides plenty of balance for all of your work needs.



Front Linkage

Ideal for your up-close and far-out work



Boom & Stick

The 313F L GC is offered with a 4.65 m (15'3") boom and a 3.0 m (9'10") stick. This combination gives you plenty of reach for general excavating applications.

Built To Last

Cat booms and sticks are built with internal baffle plates for added durability, and all undergo ultrasound inspection to ensure weld quality and reliability. Large box-section structures with thick multi-plate fabrications, castings, and forgings are used in high-stress areas such as the boom nose, boom foot, boom cylinder, and stick foot to improve durability. Also, the front linkage pins' inner bearing surfaces are welded with a self-lubricated bearing to extend service intervals and increase uptime.





Attachments

Tools to make you productive and profitable

Get The Most Out Of One Machine

The 313F L GC is a versatile machine that packs a lot of performance into a small package. You can easily expand that performance by utilizing a variety of attachments offered by Cat Work Tools.

Change Jobs Quickly

A quick coupler brings the ability to quickly change attachments and switch from job to job. The Cat Pin Grabber coupler is the secure way to decrease downtime and increase job site flexibility and overall productivity.

Dig, Finish & Break

A range of buckets dig everything from top soil to abrasive material. For finishing and grading work, compact and shallow ditch cleaning buckets fit the need. A hydraulic hammer equips the machine for breaking sidewalks, driveways, and pavement.

Move All Sorts Of Material

Choose a thumb to work with your bucket and gain instant ability to move brush, rocks, and debris at your construction site.

Set Up Your Machine For Maximum Profitability

Your Cat dealer can install hydraulic kits to properly operate all Cat Work Tool attachments, maximizing the machine's uptime and your profits.

GRAB, LOAD & BREAK



Pro Series Hydraulic Thumbs



Stiff Link Thumbs



Hydraulic Hammers

DIG & FINISH



Ditch Cleaning and Tilt Buckets



General Duty Buckets



Heavy Duty Buckets



Severe Duty Buckets

SWAP TOOLS



Center-Lock™ Pin Grabber Coupler

Simple Technologies

Solutions that make your work efficient



Link Technologies

This optional system is integrated into the machine monitoring system and is designed to help customers improve their overall fleet management effectiveness. Events and diagnostic codes as well as hours, fuel consumption, idle time, machine location, and other detailed information are transmitted to a secure web application called VisionLink®, which uses powerful tools to communicate to users and dealers.

Serviceability

Designed to make your maintenance quick and simple

Easy To Maintain

The 313F L GC is a simple, compact, easy-to-maintain machine. You can reach most routine maintenance items like fluid taps and grease points from the safety and convenience of ground level. Wide service doors provide excellent access to the radiator, pump, air cleaner, and engine compartments; doors latch in place to make your service work simpler.



Room To Move

What's behind the doors – and what isn't – contributes to the 313F L GC's ease of service. For example, the diesel particulate filter used to capture emissions is compact and maintenance free. No air-to-air aftercooler is needed, so that means more room to make cleaning cores easy. Also, the use of an easy-to-reach manual priming pump reduces the number of filters the machine needs. All of this leads to less complexity and lower owning and operating costs for you.

More Service Benefits

The fuel tank features a remote drain tube located in the pump compartment to make it easy for you to remove water and sediment during routine maintenance. It also has an engine oil drain tube to make oil changes easy without any tools.



Transportability

Sized to make getting to work quick and efficient



Easy To Move

Not only is the 313F L GC ideal for many everyday utility jobs, but it's also easy to get there because of its small size. Simply load it on tag trailer and go to work.

Safety

Features to help you day in and day out



A Safe, Quiet Cab

The ROPS-certified cab provides you with a safe working environment. It also contributes to your comfort because it's attached to a reinforced frame with special viscous mounts that limit vibration and unnecessary sound. Add in special roof lining and sealing and you have a cab that's as quiet as any of today's top pickup trucks.



Great Views

Ample glass gives you great views out front and to the side. A large rear window, aided by a low-profile engine, gives you excellent visibility out back. The split-configuration windshield features an upper window equipped with handles so you can slide it to store in the ceiling, and a large skylight provides great overhead visibility; it also serves as an emergency exit.

Smart Lights

The 313F L GC has three working lights that provide all the illumination you will need. Plus the cab and chassis lights have a time-delay function that can be set to stay on up to five minutes after the engine has been turned off to help you safely exit the machine.



Secure Contacts

The surface of the upper structure and the top of the storage box area are covered with anti-skid plates to help prevent you from slipping during maintenance. Steps on the track frame and storage box along with extended hand and guard rails to the upper deck enable you to securely work on the machine.



Complete Customer Care

Service you can count on

Worldwide Parts Availability

Cat dealers utilize a worldwide parts network to maximize your machines' uptime. Plus they can help you save money with remanufactured Cat components.

Advice You Can Trust

What are the job requirements and machine attachments? What production is needed? Your Cat dealer can provide recommendations to help you make the right machine choices.

Financial Options Just For You

Consider financing options and day-to-day operating costs. Look at dealer services that can be included in the machine's cost to yield lower owning and operating costs over time.

Support Agreements To Fit Your Needs

Cat dealers offer a variety of customer support agreements and work with you to develop a plan to meet your specific needs. These plans can cover the entire machine, including attachments, to help protect your investment.

Operating Techniques To Boost Your Profits

Improving operating techniques can boost your profits. Your Cat dealer has videos, literature, and other ideas to help you increase productivity. Caterpillar also offers simulators and certified operator training to help maximize the return on your investment.

What's Best For You Today ... And Tomorrow

Repair, rebuild, or replace? Your Cat dealer can help you evaluate the cost involved so you can make the best choice for your business.



Sustainability

Generations ahead in every way

- The C3.4B engine meets Tier 4 Final emission standards.
- The engine is fuel efficient and does not require Diesel Exhaust Fluid (DEF), which means less resource consumption.
- The engine runs on ultra-low-sulfur diesel (ULSD) fuel with 15 ppm of sulfur that meets ASTM 6751 standards.

313F L GC Hydraulic Excavator Specifications

Engine

Engine Model	Cat C3.4B	
Gross Power – SAE J1995	55 kW	74 hp
Net Power – SAE J1349	52 kW	70 hp
Engine rpm		
Operation	1,700 rpm	
Travel	1,800 rpm	
Bore	99 mm	3.90 in
Stroke	110 mm	4.33 in
Displacement	3.4 L	207 in ³

Weights

Operating Weight	13 300 kg	29,300 lb
------------------	-----------	-----------

- Long Undercarriage, Reach Boom, R3.0 (9'10") Stick, GD 0.53 m³ (0.69 yd³) Bucket and 500 mm (20 in) Shoes.

Track

Number of Shoes (each side) – Long Undercarriage	46 pieces	
Number of Track Rollers (each side) – Long Undercarriage	7 pieces	
Number of Carrier Rollers (each side)	1 piece	

Swing Mechanism

Swing Speed	11.7 rpm	
Swing Torque	30.9 kN·m	22,791 lbf-ft

Drive

Maximum Travel Speed	5.5 km/h	3.4 mph
Maximum Drawbar Pull	109.9 kN	24,706 lbf

Hydraulic System

Main System – Maximum Flow (total)	240 L/min	63.4 gal/min
Maximum Pressure – Equipment	30.5 MPa	4,424 psi
Maximum Pressure – Travel	30.5 MPa	4,424 psi
Maximum Pressure – Swing	23 MPa	3,336 psi
Pilot System – Maximum Pressure	4120 kPa	598 psi
Boom Cylinder – Bore	110 mm	4 in
Boom Cylinder – Stroke	1015 mm	40 in
Stick Cylinder – Bore	120 mm	5 in
Stick Cylinder – Stroke	1197 mm	47 in
Bucket Cylinder – Bore	100 mm	4 in
Bucket Cylinder – Stroke	939 mm	37 in

Service Refill Capacities

Fuel Tank Capacity	250 L	66.0 gal
Cooling System	17.9 L	4.7 gal
Engine Oil	8 L	2.1 gal
Swing Drive	3 L	0.8 gal
Final Drive	3 L	0.8 gal
Hydraulic System (including tank)	164 L	43.3 gal
Hydraulic Tank	90.6 L	23.9 gal

Sound

ISO 6395 (external)	99 dB(A)
ISO 6396 (inside cab)	72 dB(A)

- When properly installed and maintained, the cab offered by Caterpillar, when tested with doors and windows closed according to ANSI/SAE J1166 OCT98, meets OSHA and MSHA requirements for operator sound exposure limits in effect at time of manufacture.
- Hearing protection may be needed when operating with an open operator station and cab (when not properly maintained or doors/windows open) for extended periods or in a noisy environment.

Standards

Brakes	ISO 10265
Cab ROPS	ISO 12117-2:2008
Cab OPG (Operator Protective Guards)	ISO 10262:1998 Level 2 SAE J1356 MAR2013

313F L GC Hydraulic Excavator Specifications

Dimensions

All dimensions are approximate.

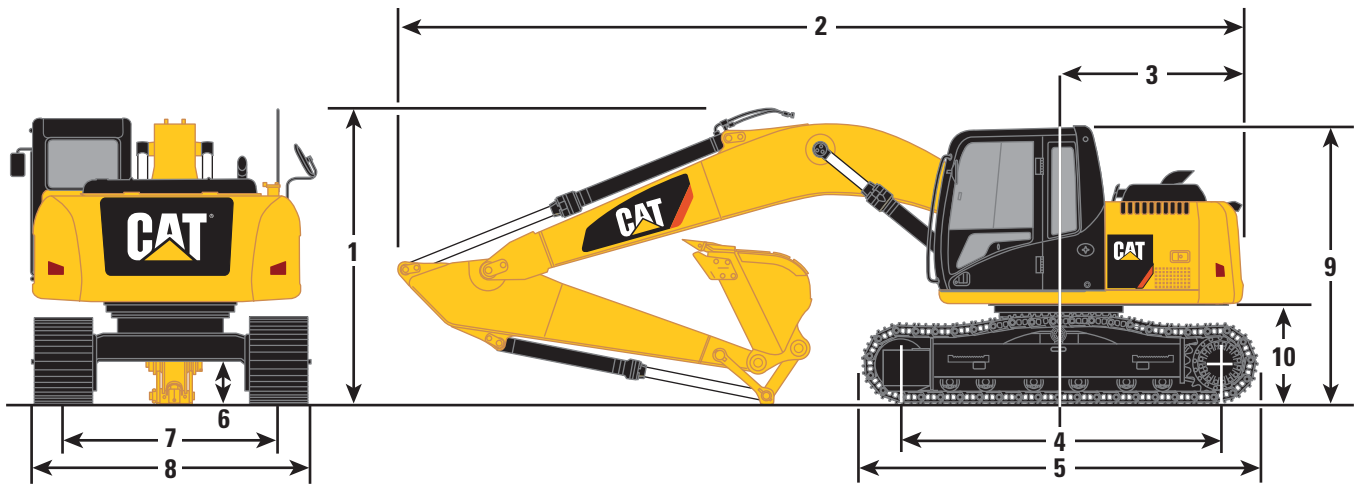

Boom Options

Reach Boom
4.65 m (15'3")

Stick Options

R3.0 (9'10")

R2.5 (8'2")

	R3.0 (9'10")	R2.5 (8'2")
1 Shipping Height	2830 mm 9'3"	2830 mm 9'3"
2 Shipping Length – Long Undercarriage	7700 mm 25'3"	7680 mm 25'2"
Shipping Length with Blade – Long Undercarriage	7960 mm 26'1"	7940 mm 26'0"
3 Tail Swing Radius	2180 mm 7'1"	2180 mm 7'1"
4 Length to Center of Rollers – Long Undercarriage	3040 mm 10'0"	3040 mm 10'0"
5 Track Length – Long Undercarriage	3740 mm 12'3"	3740 mm 12'3"
6 Ground Clearance	440 mm 1'5"	440 mm 1'5"
7 Track Gauge – Long Undercarriage (shipping)*	1990 mm 6'6"	1990 mm 6'6"
8 Transport Width – Long Undercarriage		
500 mm (20 in) Shoes	2490 mm 8'2"	2490 mm 8'2"
700 mm (28 in) Shoes	2690 mm 8'10"	2690 mm 8'10"
9 Cab Height	2760 mm 9'1"	2760 mm 9'1"
Cab Height with Top Guard	2900 mm 9'6"	2900 mm 9'6"
10 Counterweight Clearance	900 mm 2'11"	900 mm 2'11"

*With GD 0.53 m³ (0.69 yd³) Bucket.

313F L GC Hydraulic Excavator Specifications

Working Ranges

All dimensions are approximate.

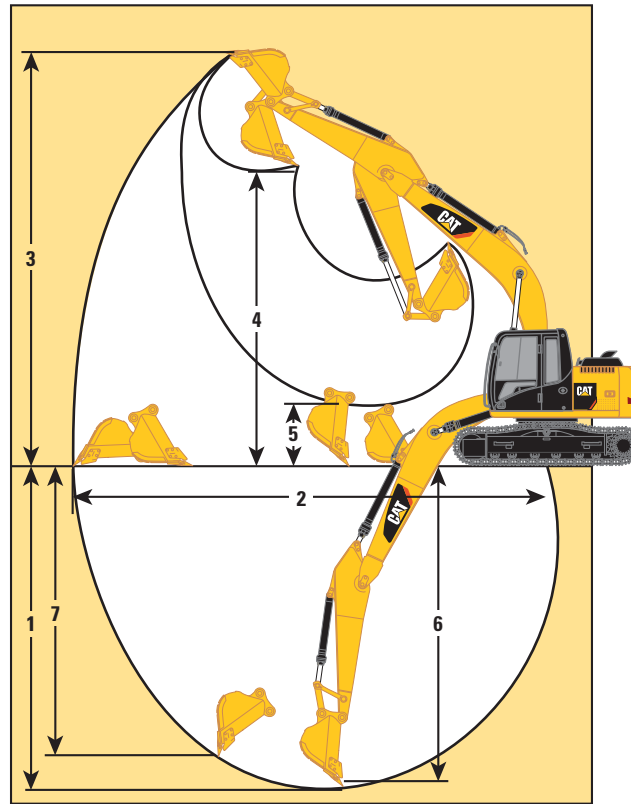

Boom Options

Reach Boom
4.65 m (15'3")

Stick Options

R3.0 (9'10")

R2.5 (8'2")

Bucket

GD 0.53 m³ (0.69 yd³)

GD 0.53 m³ (0.69 yd³)

	R3.0 (9'10")		R2.5 (8'2")	
	GD 0.53 m ³ (0.69 yd ³)		GD 0.53 m ³ (0.69 yd ³)	
1 Maximum Digging Depth	6040 mm	19'9"	5540 mm	18'2"
2 Maximum Reach at Ground Line	8620 mm	28'3"	8170 mm	26'10"
3 Maximum Cutting Height	8710 mm	28'6"	8490 mm	27'8"
4 Maximum Loading Height	6330 mm	20'9"	6100 mm	20'0"
5 Minimum Loading Height	1530 mm	5'0"	2020 mm	6'8"
6 Maximum Depth Cut for 2240 mm (8 ft) Level Bottom	5860 mm	19'2"	5330 mm	17'6"
7 Maximum Vertical Wall Digging Depth	5200 mm	17'0"	4840 mm	15'1"
Bucket Digging Force (SAE)	86 kN	19,300 lbf	86 kN	19,300 lbf
Stick Digging Force (SAE)	57 kN	12,800 lbf	64 kN	14,400 lbf

Blade

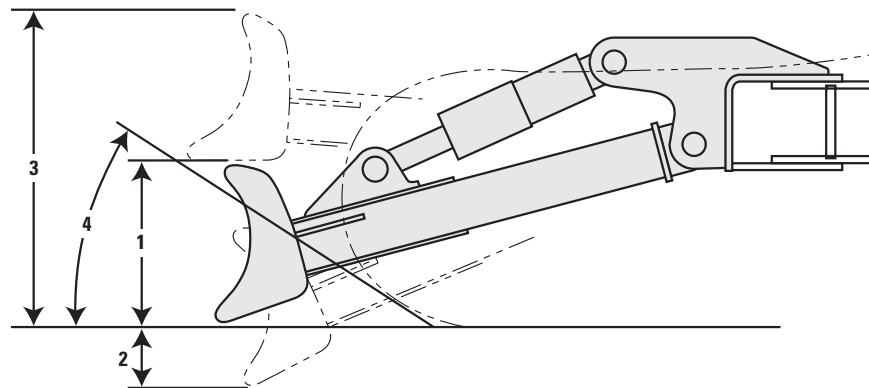

1 Blade Height	628 mm	2'1"
2 Maximum Lowering Depth from Ground	567 mm	1'10"
3 Maximum Raising Height above Ground	998 mm	3'3"
4 Approach Angle	23.3 degrees	

313F L GC Hydraulic Excavator Specifications

Operating Weights and Ground Pressures

	700 mm (28 in) Shoes				500 mm (20 in) Shoes			
	Weight		Ground Pressure		Weight		Ground Pressure	
	kg	lb	kPa	psi	kg	lb	kPa	psi
0.53 m³ (0.69 yd³) GD Bucket without Blade								
Reach Boom – 4.65 m (15'3")								
R3.0 (9'10") Stick	13 800	30,400	29.4	4.3	13 300	29,300	39.7	5.8
R2.5 (8'2") Stick	13 700	30,200	29.2	4.2	13 200	29,100	39.4	5.7
0.53 m³ (0.69 yd³) GD Bucket with Blade								
Reach Boom – 4.65 m (15'3")								
R3.0 (9'10") Stick	14 600	32,200	31.1	4.5	14 100	31,100	42.0	6.1
R2.5 (8'2") Stick	14 500	32,000	30.9	4.5	14 000	30,900	41.7	6.1

Major Component Weights

	kg	lb
Base Machine (with boom cylinder, without counterweight, front linkage and track)	4420	9,750
Long Undercarriage	2650	5,840
Counterweight	2450	5,400
Reach Boom – 4.65 m (15'3") Boom (includes lines, pins and stick cylinder)	1030	2,270
R3.0 (9'10") Stick (includes lines, pins, bucket cylinder and bucket linkage)	650	1,430
R2.5 (8'2") Stick (includes lines, pins, bucket cylinder and bucket linkage)	570	1,260
500 mm (20 in) Triple Grouser Track Shoes (long/per two track)	1570	3,460
700 mm (28 in) Triple Grouser Track Shoes (long/per two track)	2070	4,560
2500 mm (8'2") Blade	800	1,760
2700 mm (8'10") Blade	820	1,810
GD 0.53 m ³ (0.69 yd ³) Bucket (with sidecutter and tip)	460	1,010

313F L GC Hydraulic Excavator Specifications

Reach Boom Lift Capacities – Counterweight: 2.45 mt (2.7 t) – Without Blade

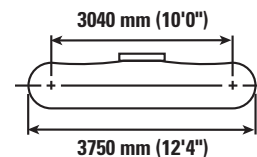
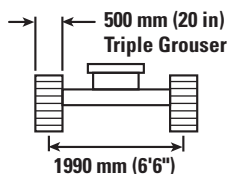
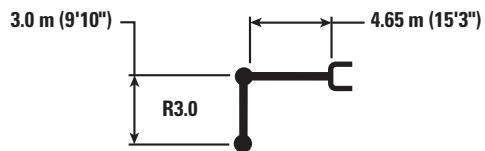

		1.5 m/5.0 ft		3.0 m/10.0 ft		4.5 m/15.0 ft		6.0 m/20.0 ft		7.5 m/25.0 ft		mm in		
7.5 m 25.0 ft	kg lb											*2550	*2550	4370
6.0 m 20.0 ft	kg lb											*2100	*2100	5950 240
4.5 m 15.0 ft	kg lb							*3150 *6,850	2450 5,250			*2000	1950	6860 270
3.0 m 10.0 ft	kg lb					*3850 *8,350	3700 7,950	*3450 *7,500	2400 5,100			*2000	1700	7360 290
1.5 m 5.0 ft	kg lb			*7550 *16,250	6250 13,450	*4900 *10,600	3450 7,400	3550 7,600	2250 4,850	*2150	1600	*2050	1600	7520 300
0 m 0 ft	kg lb			*7850 *18,150	5800 12,450	5300 11,300	3250 6,950	3400 7,350	2150 4,650			*2300	1600	7380 290
-1.5 m -5.0 ft	kg lb	*4500 *10,050	*4500 *10,050	*9300 *20,200	5650 12,150	5150 11,050	3100 6,700	3350 7,200	2100 4,550			*2700	1750	6910 280
-3.0 m -10.0 ft	kg lb	*7500 *16,850	*7500 *16,850	*8550 *18,450	5700 12,300	5150 11,050	3100 6,700	3400	2150			3350	2100	6040 240
-4.5 m -15.0 ft	kg lb			*6450 *13,650	5950 12,750	*4050	3250					*4000	3250	4530 180



ISO 10567



*Indicates that the load is limited by hydraulic lifting capacity rather than tipping load. The above loads are in compliance with hydraulic excavator lift capacity standard ISO 10567:2007. They do not exceed 87% of hydraulic lifting capacity or 75% of tipping load. Weight of all lifting accessories must be deducted from the above lifting capacities. Lifting capacities are based on the machine standing on a firm, uniform supporting surface. The use of a work tool attachment point to handle/lift objects, could affect the machine lift performance.

Lift capacity stays with ±5% for all available track shoes.

Always refer to the appropriate Operation and Maintenance Manual for specific product information.

313F L GC Hydraulic Excavator Specifications

Reach Boom Lift Capacities – Counterweight: 2.45 mt (2.7 t) – Without Blade

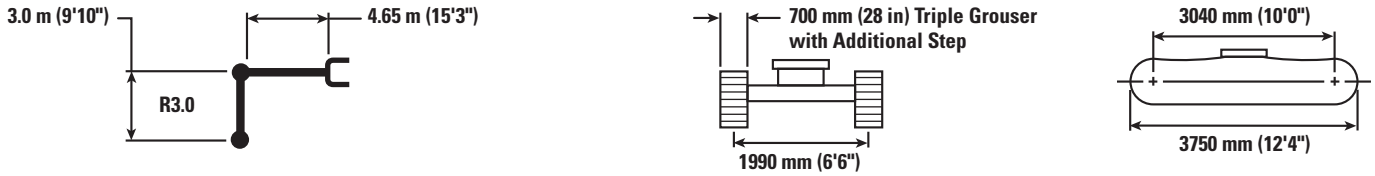

		1.5 m/5.0 ft		3.0 m/10.0 ft		4.5 m/15.0 ft		6.0 m/20.0 ft		7.5 m/25.0 ft		mm in		
7.5 m 25.0 ft	kg lb											*2550	*2550	4370
6.0 m 20.0 ft	kg lb											*2100	*2100	5950 240
4.5 m 15.0 ft	kg lb							*3150 *6,850	2550 5,450			*2000	*2000	6860 270
3.0 m 10.0 ft	kg lb					*3850 *8,350	3800 8,200	*3450 *7,500	2450 5,300			*2000	1800	7360 290
1.5 m 5.0 ft	kg lb			*7550 *16,250	6450 13,900	*4900 *10,600	3550 7,650	3650 7,850	2350 5,050	*2150	1700	*2050	1650	7520 300
0 m 0 ft	kg lb			*7850 *18,150	6000 12,900	5450 11,750	3350 7,200	3550 7,650	2250 4,850			*2300	1700	7380 290
-1.5 m -5.0 ft	kg lb	*4500 *10,050	*4500 *10,050	*9300 *20,200	5900 12,600	5350 11,500	3250 6,950	3500 7,500	2200 4,700			*2700	1850	6910 280
-3.0 m -10.0 ft	kg lb	*7500 *16,850	*7500 *16,850	*8550 *18,450	5950 12,750	5350 11,500	3250 6,950	3500 7,500	2200			3500	2200	6040 240
-4.5 m -15.0 ft	kg lb			*6450 *13,650	6150 13,200	*4050	3400					*4000	3350	4530 180



ISO 10567



*Indicates that the load is limited by hydraulic lifting capacity rather than tipping load. The above loads are in compliance with hydraulic excavator lift capacity standard ISO 10567:2007. They do not exceed 87% of hydraulic lifting capacity or 75% of tipping load. Weight of all lifting accessories must be deducted from the above lifting capacities. Lifting capacities are based on the machine standing on a firm, uniform supporting surface. The use of a work tool attachment point to handle/lift objects, could affect the machine lift performance.









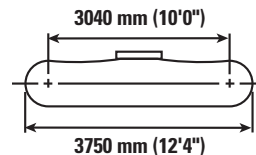
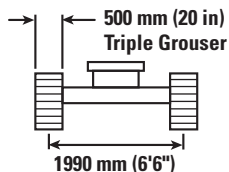
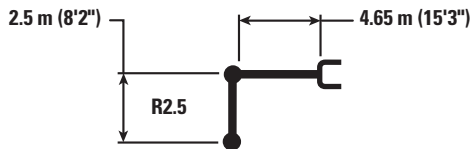

Lift capacity stays with ±5% for all available track shoes.

Always refer to the appropriate Operation and Maintenance Manual for specific product information.

313F L GC Hydraulic Excavator Specifications

Reach Boom Lift Capacities – Counterweight: 2.45 mt (2.7 t) – Without Blade



		1.5 m/5.0 ft		3.0 m/10.0 ft		4.5 m/15.0 ft		6.0 m/20.0 ft				mm in
												
6.0 m 20.0 ft	kg lb					*3350 *7,450	*3350 *7,450			*2450 *5,400	*2450 *5,400	5380 210
4.5 m 15.0 ft	kg lb					*3550 *7,750	*3550 *7,750	*3500 *7,100	2450 5,200	*2250 *4,950	2200 4,850	6370 250
3.0 m 10.0 ft	kg lb			*5850 *12,500	*5850 *12,500	*4350 *9,400	3650 7,850	3650 7,800	2350 5,100	*2250 *4,900	1900 4,150	6900 280
1.5 m 5.0 ft	kg lb			*8450 *18,100	6100 13,150	*5300 *11,500	3400 7,350	3550 7,600	2300 4,900	*2350 *5,100	1800 3,900	7080 280
0 m 0 ft	kg lb			*6900 *15,900	5800 12,500	5300 11,350	3250 6,950	3450 7,400	2200 4,700	*2600 *5,650	1800 3,950	6930 280
-1.5 m -5.0 ft	kg lb	*4850 *10,900	*4850 *10,900	*9200 *19,950	5750 12,400	5200 11,200	3200 6,850	3400 7,350	2150 4,650	*3100 *6,800	2000 4,350	6430 260
-3.0 m -10.0 ft	kg lb	*8750 *19,750	*8750 *19,750	*8050 *17,400	5850 12,600	5250 11,300	3200 6,900			3950 8,750	2500 5,500	5480 220



ISO 10567



*Indicates that the load is limited by hydraulic lifting capacity rather than tipping load. The above loads are in compliance with hydraulic excavator lift capacity standard ISO 10567:2007. They do not exceed 87% of hydraulic lifting capacity or 75% of tipping load. Weight of all lifting accessories must be deducted from the above lifting capacities. Lifting capacities are based on the machine standing on a firm, uniform supporting surface. The use of a work tool attachment point to handle/lift objects, could affect the machine lift performance.









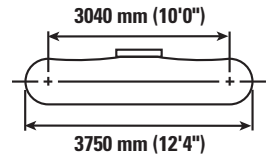
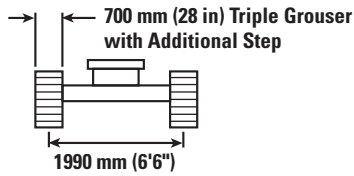
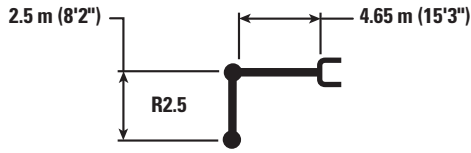

Lift capacity stays with ±5% for all available track shoes.

Always refer to the appropriate Operation and Maintenance Manual for specific product information.

313F L GC Hydraulic Excavator Specifications

Reach Boom Lift Capacities – Counterweight: 2.45 mt (2.7 t) – Without Blade



		1.5 m/5.0 ft		3.0 m/10.0 ft		4.5 m/15.0 ft		6.0 m/20.0 ft				
												mm in
6.0 m 20.0 ft	kg lb					*3350 *7,450	*3350 *7,450			*2450 *5,400	*2450 *5,400	5380 210
4.5 m 15.0 ft	kg lb					*3550 *7,750	*3550 *7,750	*3500 *7,100	2500 5,350	*2250 *4,950	*2250 *4,950	6370 250
3.0 m 10.0 ft	kg lb			*5850 *12,500	*5850 *12,500	*4350 *9,400	3750 8,100	*3750 8,100	2450 5,250	*2250 *4,900	1950 4,350	6900 280
1.5 m 5.0 ft	kg lb			*8450 *18,100	6350 13,600	*5300 *11,500	3550 7,600	3650 7,850	2350 5,050	*2350 *5,100	1850 4,050	7080 280
0 m 0 ft	kg lb			*6900 *15,900	6050 12,950	5500 11,800	3350 7,250	3600 7,700	2300 4,900	*2600 *5,650	1900 4,100	6930 280
-1.5 m -5.0 ft	kg lb	*4850 *10,900	*4850 *10,900	*9200 *19,950	6000 12,850	5400 11,600	3300 7,100	3550 7,600	2250 4,850	*3100 *6,800	2050 4,550	6430 260
-3.0 m -10.0 ft	kg lb	*8750 *19,750	*8750 *19,750	*8050 *17,400	6100 13,050	5450 11,700	3350 7,150			4100 9,100	2600 5,750	5480 220



ISO 10567



*Indicates that the load is limited by hydraulic lifting capacity rather than tipping load. The above loads are in compliance with hydraulic excavator lift capacity standard ISO 10567:2007. They do not exceed 87% of hydraulic lifting capacity or 75% of tipping load. Weight of all lifting accessories must be deducted from the above lifting capacities. Lifting capacities are based on the machine standing on a firm, uniform supporting surface. The use of a work tool attachment point to handle/lift objects, could affect the machine lift performance.

Lift capacity stays with ±5% for all available track shoes.

Always refer to the appropriate Operation and Maintenance Manual for specific product information.

313F L GC Hydraulic Excavator Specifications

Reach Boom Lift Capacities – Counterweight: 2.45 mt (2.7 t) – Blade Down

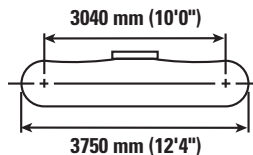
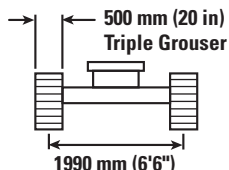
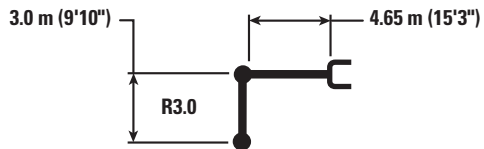

		1.5 m/5.0 ft		3.0 m/10.0 ft		4.5 m/15.0 ft		6.0 m/20.0 ft		7.5 m/25.0 ft		mm in		
7.5 m 25.0 ft	kg lb											*2550	*2550	4370
6.0 m 20.0 ft	kg lb											*2100	*2100	5950 240
4.5 m 15.0 ft	kg lb							*3150 *6,850	2800 6,000			*2000	*2000	6860 270
3.0 m 10.0 ft	kg lb					*3850 *8,350	*3850	*3450 *7,500	2700 5,800			*2000	1950	7360 290
1.5 m 5.0 ft	kg lb			*7550 *16,250	7250 15,600	*4900 *10,600	3950 8,450	*3900 *8,500	2600 5,600	*2150	1850	*2050	1850	7520 300
0 m 0 ft	kg lb			*7850 *18,150	6800 14,600	*5750 *12,450	3750 8,000	*4300 *9,350	2500 5,350			*2300	1850	7380 290
-1.5 m -5.0 ft	kg lb	*4500 *10,050	*4500 *10,050	*9300 *20,200	6650 14,300	*6100 *13,150	3600 7,800	*4450 *9,650	2450 5,250			*2700	2050	6910 280
-3.0 m -10.0 ft	kg lb	*7500 *16,850	*7500 *16,850	*8550 *18,450	6700 14,400	*5750 *12,400	3600 7,800	*3950	2450			*3550	2450	6040 240
-4.5 m -15.0 ft	kg lb			*6450 *13,650	*6450 *13,650	*4050	3750					*4000	3750	4530 180



ISO 10567



*Indicates that the load is limited by hydraulic lifting capacity rather than tipping load. The above loads are in compliance with hydraulic excavator lift capacity standard ISO 10567:2007. They do not exceed 87% of hydraulic lifting capacity or 75% of tipping load. Weight of all lifting accessories must be deducted from the above lifting capacities. Lifting capacities are based on the machine standing on a firm, uniform supporting surface. The use of a work tool attachment point to handle/lift objects, could affect the machine lift performance.









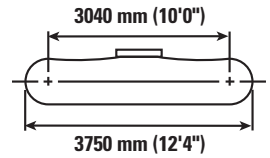
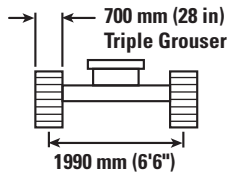
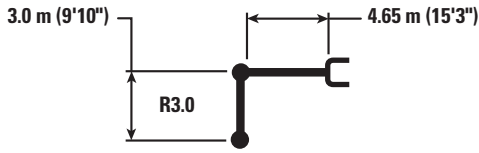



Lift capacity stays with ±5% for all available track shoes.

Always refer to the appropriate Operation and Maintenance Manual for specific product information.

313F L GC Hydraulic Excavator Specifications

Reach Boom Lift Capacities – Counterweight: 2.45 mt (2.7 t) – Blade Down



		1.5 m/5.0 ft		3.0 m/10.0 ft		4.5 m/15.0 ft		6.0 m/20.0 ft		7.5 m/25.0 ft				mm in
														
7.5 m 25.0 ft	kg lb											*2550	*2550	4370
6.0 m 20.0 ft	kg lb											*2100	*2100	5950 240
4.5 m 15.0 ft	kg lb							*3150 *6,850	3000 6,400			*2000	*2000	6860 270
3.0 m 10.0 ft	kg lb					*3850 *8,350	*3850	*3450 *7,500	2900 6,250			*2000	*2000	7360 290
1.5 m 5.0 ft	kg lb			*7550 *16,250	*7550 *16,250	*4900 *10,600	4250 9,150	*3900 *8,500	2800 6,000	*2150	2000	*2050	2000	7520 300
0 m 0 ft	kg lb			*7850 *18,150	7450 15,950	*5750 *12,450	4050 8,650	*4300 *9,350	2700 5,800			*2300	2050	7380 290
-1.5 m -5.0 ft	kg lb	*4500 *10,050	*4500 *10,050	*9300 *20,200	7300 15,650	*6100 *13,150	3950 8,450	*4450 *9,650	2650 5,700			*2700	2200	6910 280
-3.0 m -10.0 ft	kg lb	*7500 *16,850	*7500 *16,850	*8550 *18,450	7350 15,750	*5750 *12,400	3950 8,450	*3950	2650			*3550	2650	6040 240
-4.5 m -15.0 ft	kg lb			*6450 *13,650	*6450 *13,650	*4050	*4050					*4000	*4000	4530 180



ISO 10567



*Indicates that the load is limited by hydraulic lifting capacity rather than tipping load. The above loads are in compliance with hydraulic excavator lift capacity standard ISO 10567:2007. They do not exceed 87% of hydraulic lifting capacity or 75% of tipping load. Weight of all lifting accessories must be deducted from the above lifting capacities. Lifting capacities are based on the machine standing on a firm, uniform supporting surface. The use of a work tool attachment point to handle/lift objects, could affect the machine lift performance.









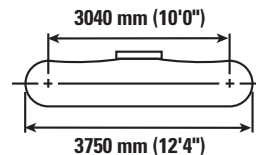
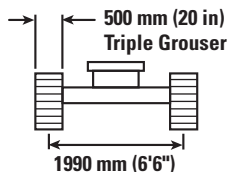
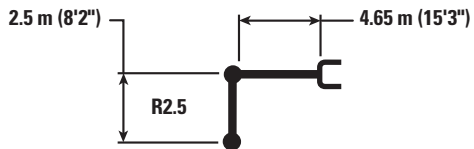

Lift capacity stays with ±5% for all available track shoes.

Always refer to the appropriate Operation and Maintenance Manual for specific product information.

313F L GC Hydraulic Excavator Specifications

Reach Boom Lift Capacities – Counterweight: 2.45 mt (2.7 t) – Blade Down



		1.5 m/5.0 ft		3.0 m/10.0 ft		4.5 m/15.0 ft		6.0 m/20.0 ft				mm in
												
6.0 m 20.0 ft	kg lb					*3350 *7,450	*3350 *7,450			*2450 *5,400	*2450 *5,400	5380 210
4.5 m 15.0 ft	kg lb					*3550 *7,750	*3550 *7,750	*3500 *7,100	2750 5,900	*2250 *4,950	*2250 *4,950	6370 250
3.0 m 10.0 ft	kg lb			*5850 *12,500	*5850 *12,500	*4350 *9,400	4150 8,950	*3750 *8,200	2700 5,800	*2250 *4,900	2150 4,800	6900 280
1.5 m 5.0 ft	kg lb			*8450 *18,100	7150 15,300	*5300 *11,500	3900 8,400	*4150 *9,050	2600 5,600	*2350 *5,100	2050 4,500	7080 280
0 m 0 ft	kg lb			*6900 *15,900	6800 14,600	*6000 *13,000	3750 8,050	*4500 *9,700	2550 5,400	*2600 *5,650	2100 4,550	6930 280
-1.5 m -5.0 ft	kg lb	*4850 *10,900	*4850 *10,900	*9200 *19,950	6750 14,500	*6150 *13,250	3700 7,900	*4450 *9,600	2500 5,350	*3100 *6,800	2300 5,050	6430 260
-3.0 m -10.0 ft	kg lb	*8750 *19,750	*8750 *19,750	*8050 *17,400	6850 14,750	*5500 *11,800	3700 8,000			*4200 *9,200	2850 6,350	5480 220



ISO 10567



*Indicates that the load is limited by hydraulic lifting capacity rather than tipping load. The above loads are in compliance with hydraulic excavator lift capacity standard ISO 10567:2007. They do not exceed 87% of hydraulic lifting capacity or 75% of tipping load. Weight of all lifting accessories must be deducted from the above lifting capacities. Lifting capacities are based on the machine standing on a firm, uniform supporting surface. The use of a work tool attachment point to handle/lift objects, could affect the machine lift performance.









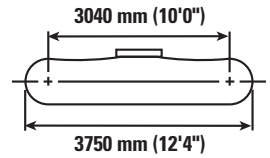
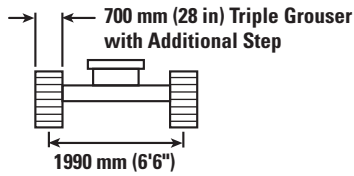
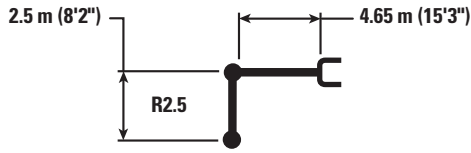

Lift capacity stays with ±5% for all available track shoes.

Always refer to the appropriate Operation and Maintenance Manual for specific product information.

313F L GC Hydraulic Excavator Specifications

Reach Boom Lift Capacities – Counterweight: 2.45 mt (2.7 t) – Blade Down



		1.5 m/5.0 ft		3.0 m/10.0 ft		4.5 m/15.0 ft		6.0 m/20.0 ft				mm in
												
6.0 m 20.0 ft	kg lb					*3350 *7,450	*3350 *7,450			*2450 *5,400	*2450 *5,400	5380 210
4.5 m 15.0 ft	kg lb					*3550 *7,750	*3550 *7,750	*3500 *7,100	2950 6,350	*2250 *4,950	*2250 *4,950	6370 250
3.0 m 10.0 ft	kg lb			*5850 *12,500	*5850 *12,500	*4350 *9,400	*4350 *9,400	*3750 *8,200	2900 6,250	*2250 *4,900	*2250 *4,900	6900 280
1.5 m 5.0 ft	kg lb			*8450 *18,100	7750 16,700	*5300 *11,500	4250 9,100	*4150 *9,050	2800 6,050	*2350 *5,100	2200 4,850	7080 280
0 m 0 ft	kg lb			*6900 *15,900	*6900 *15,900	*6000 *13,000	4050 8,700	*4500 *9,700	2750 5,850	*2600 *5,650	2250 4,950	6930 280
-1.5 m -5.0 ft	kg lb	*4850 *10,900	*4850 *10,900	*9200 *19,950	7400 15,850	*6150 *13,250	4000 8,550	*4450 *9,600	2700 5,800	*3100 *6,800	2450 5,450	6430 260
-3.0 m -10.0 ft	kg lb	*8750 *19,750	*8750 *19,750	*8050 *17,400	7500 16,050	*5500 *11,800	4000 8,650			*4200 *9,200	3100 6,900	5480 220



ISO 10567



*Indicates that the load is limited by hydraulic lifting capacity rather than tipping load. The above loads are in compliance with hydraulic excavator lift capacity standard ISO 10567:2007. They do not exceed 87% of hydraulic lifting capacity or 75% of tipping load. Weight of all lifting accessories must be deducted from the above lifting capacities. Lifting capacities are based on the machine standing on a firm, uniform supporting surface. The use of a work tool attachment point to handle/lift objects, could affect the machine lift performance.

Lift capacity stays with ±5% for all available track shoes.

Always refer to the appropriate Operation and Maintenance Manual for specific product information.



313F L GC Work Tool Offering Guide*

Boom Type	Reach Boom	
Stick Size	R3.0 (9'10")	R2.5 (8'2")
Hydraulic Hammers	H95Es H110Es H115Es	H95Es H110Es H115Es
Thumbs	These work tools are available for the 313F L GC. Consult your Cat dealer for proper match.	
Center-Lock™ Pin Grabber Coupler		
Dedicated Quick Coupler		

*Offerings not available in all areas. Maximum weight limitation for ROPS certification is (14 700 kg/32,400 lb). Matches are dependent on excavator configurations. Consult your Cat dealer to determine what is offered in your area and for proper work tool match.

313F L GC Hydraulic Excavator Specifications

Bucket Specifications and Compatibility

	Width		Capacity		Weight		Fill	Reach Boom	
	mm	in	m ³	yd ³	kg	lb	%	R3.0 (9'10")	R2.5 (8'2")
Without Quick Coupler									
General Duty (GD)	450	18	0.20	0.27	276	608	100	●	●
	600	24	0.31	0.40	326	719	100	●	●
	750	30	0.41	0.54	374	823	100	●	●
	900	36	0.53	0.69	423	932	100	●	●
	1050	42	0.65	0.84	469	1,034	100	⊙	●
	1050	42	0.65	0.84	458	1,010	100	⊙	●
	1200	48	0.76	1.00	510	1,125	100	X	X
Severe Duty (SD)	600	24	0.31	0.40	367	810	90	●	●
	750	30	0.41	0.54	425	936	90	●	●
	900	36	0.53	0.69	483	1,065	90	●	●
	1050	42	0.65	0.84	529	1,166	90	●	●
Maximum load pin-on (payload + bucket)							kg	1710	1930
							lb	3,775	4,260
With Pin Grabber Coupler									
General Duty (GD)	450	18	0.20	0.27	276	608	100	●	●
	600	24	0.31	0.40	326	719	100	●	●
	750	30	0.41	0.54	374	823	100	●	●
	900	36	0.53	0.69	423	932	100	⊙	●
	1050	42	0.65	0.84	469	1,034	100	⊖	⊙
	1050	42	0.65	0.84	458	1,010	100	⊖	⊙
	1200	48	0.76	1.00	510	1,125	100	○	⊖
Severe Duty (SD)	600	24	0.31	0.40	367	810	90	●	●
	750	30	0.41	0.54	425	936	90	●	●
	900	36	0.53	0.69	483	1,065	90	●	●
	1050	42	0.65	0.84	529	1,166	90	⊖	⊙
Maximum load with coupler (payload + bucket)							kg	1460	1680
							lb	2,225	3,710

The above loads are in compliance with hydraulic excavator standard EN474, they do not exceed 87% of hydraulic lifting capacity or 75% of tipping capacity with front linkage fully extended at ground line with bucket curled.

Capacity based on ISO 7451.

Bucket weight with long tips.

Maximum Material Density:

- 2100 kg/m³ (3,500 lb/yd³)
- ⊙ 1800 kg/m³ (3,000 lb/yd³)
- ⊖ 1500 kg/m³ (2,500 lb/yd³)
- 1200 kg/m³ (2,000 lb/yd³)
- X Not recommended

Caterpillar recommends using appropriate work tools to maximize the value customers receive from our products. Use of work tools, including buckets, which are outside of Caterpillar's recommendations or specifications for weight, dimensions, flows, pressures, etc. may result in less-than-optimal performance, including but not limited to reductions in production, stability, reliability, and component durability. Improper use of a work tool resulting in sweeping, prying, twisting and/or catching of heavy loads will reduce the life of the boom and stick.

Standard Equipment

Standard equipment may vary. Consult your Cat dealer for details.

ENGINE

- C3.4B Tier 4 Final diesel engine
- 2300 m (7,500 ft) altitude capability
- Manual priming pump
- Automatic engine speed control
- Two-speed travel
- Side-by-side cooling system
- Radial seal air filter
- Primary filter with water separator and water separator indicator
- Secondary filter
- Standard battery –18° C (0° F)

HYDRAULIC SYSTEM

- Regeneration circuit for boom and stick
- Reverse swing dampening valve
- Automatic swing parking brake
- High-performance hydraulic return filter
- HP stackable valve and medium and QC valve capability
- Additional auxiliary pump and circuit capability

CAB

- Pressurized operator station with positive filtration
- Sliding upper door window
- Removable lower windshield with storage bracket
- Coat hook
- Beverage holder
- Literature holder
- Two 12V stereo speakers
- Storage shelf
- Color LCD display
- Adjustable armrest
- Adjustable joystick consoles
- Neutral lever for all controls
- Travel control pedals with removable hand levers
- 7 amp power outlet
- Laminated glass front upper window
- Tempered glass lower, sides, and rear windows
- Windshield wiper

UNDERCARRIAGE

- Center track guiding guard
- Grease Lubricated Track GLT2 with resin seal
- Towing eye on base frame
- Standard bottom guard

COUNTERWEIGHT

- 2.45 mt (2.7 t)

ELECTRICAL

- 50 amp alternator
- Circuit breaker
- Beacon capability

LIGHTS

- Cab light with time delay
- Halogen boom light with time delay
- Exterior light integrated into storage box

SECURITY

- Cat one key security system
- Door locks
- Cap locks on fuel tanks
- Lockable external tool/storage box
- Signaling/warning horn
- Secondary engine shutoff switch
- Openable skylight
- Rearview camera-ready
- Rear window for emergency exit

313F L GC Optional Equipment

Optional Equipment

Optional equipment may vary. Consult your Cat dealer for details.

ENGINE

- Electric refueling pump
- Cold weather battery –25° C (–13° F)

HYDRAULIC SYSTEM

- Auxiliary hydraulics
- High-pressure line
- Medium-pressure line
- Quick coupler line
- Boom lowering and stick lowering control valve
- Boom drift and stick drift reduction valve
- Two-way control pattern changer

CAB

- Rear window for secondary exit
- High-back air suspension seat
- High-back mechanical suspension seat
- Rain protector
- Cab mirror
- Travel alarm
- AM/FM radio with MP3 auxiliary audio port

UNDERCARRIAGE

- 500 mm (20 in) triple grouser shoes
- 700 mm (28 in) triple grouser shoes
- Rubber pad for 500 mm triple grouser shoes
- Segmented (2 piece) track guiding guard
- 2500 mm (8'2") blade with replaceable cutting edge
- 2700 mm (8'10") blade with replaceable cutting edge
- Swivel guard

FRONT LINKAGE

- Quick coupler
- Bucket linkage
- 2.5 m (8'2") stick

LIGHTS

- Halogen boom light (right side)

SECURITY

- FOGS
- Security system
- Rearview camera

TECHNOLOGY

- Product Link™

For more complete information on Cat products, dealer services, and industry solutions, visit us on the web at www.cat.com

AEHQ7405-02 (03-2016)
Replaces AEHQ7405-01

© 2016 Caterpillar
All rights reserved

Materials and specifications are subject to change without notice. Featured machines in photos may include additional equipment. See your Cat dealer for available options.

CAT, CATERPILLAR, SAFETY.CAT.COM, their respective logos, "Caterpillar Yellow" and the "Power Edge" trade dress, as well as corporate and product identity used herein, are trademarks of Caterpillar and may not be used without permission.

VisionLink is a trademark of Trimble Navigation Limited, registered in the United States and in other countries.

